



DATABÁZE ESPACENET

Martina Machátová

Poslední aktualizace: 11. března 2024

Espacenet







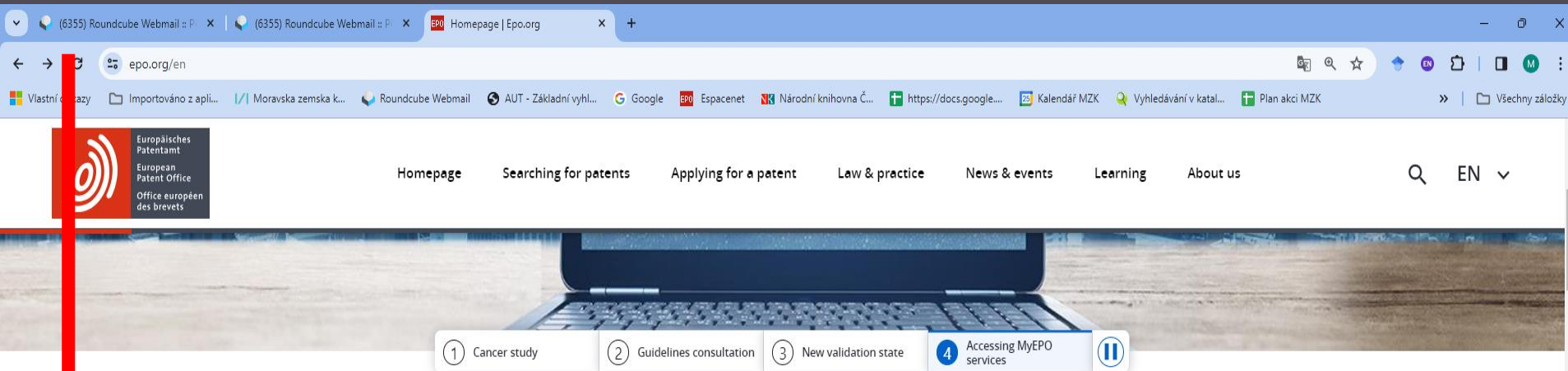

- <https://worldwide.espacenet.com/>
- Databáze obsahuje více než 150 milionů patentových dokumentů z řady zemí, největší volně přístupná patentová databáze.
- Buduje ji Evropský patentový úřad.
<https://www.epo.org/>

Evropský patentový úřad

<https://www.epo.org/>



The EPO provides high-quality patents and efficient services that foster innovation, competitiveness and economic growth.

 Searching for patents <p>Find out what technology already exists</p> <ul style="list-style-type: none">→ European Patent Register→ European Publication Server→ Espacenet patent search <p> New to patents?</p>	 Applying for a patent <p>Protect your invention</p> <ul style="list-style-type: none">→ Access MyEPO services→ Online Filing 2.0→ Find a professional representative <p> New to patents?</p>	 Law and practice <p>Keep pace with the latest legal developments</p> <ul style="list-style-type: none">→ Official Journal→ European Patent Convention→ Guidelines for Examination	 Boards of Appeal <p>Independent review of EPO decisions</p> <ul style="list-style-type: none">→ Decisions→ Case law of the Boards of Appeal→ Oral proceedings
--	---	---	---

Espacenet

Pomůcky



Kapesní průvodce v angličtině:

[http://documents.epo.org/projects/babylon/eponet.nsf/0/8C12F50E07515DBEC12581B00050BFDA/\\$File/espacenet-pocket-guide_en.pdf](http://documents.epo.org/projects/babylon/eponet.nsf/0/8C12F50E07515DBEC12581B00050BFDA/$File/espacenet-pocket-guide_en.pdf)

Nahrávky z instruktážních webinářů v angličtině

Úvod do Espacenetu:

<https://e-courses.epo.org/mod/streaming/view.php?id=9277>

Pokročilé funkce Espacenetu:

<https://e-courses.epo.org/mod/streaming/view.php?id=9278>

Espacenet

Pomůcky



Instruktažní video v angličtině s českými titulky:

<https://www.youtube.com/watch?v=KLxnB5dqP70>

Jestliže české titulky nenaskočí automaticky, lze v nastavení videa vybrat „titulky“ a pak „čeština“.

Espacenet

Vstup do databáze:

<https://www.epo.org/en/searching-for->

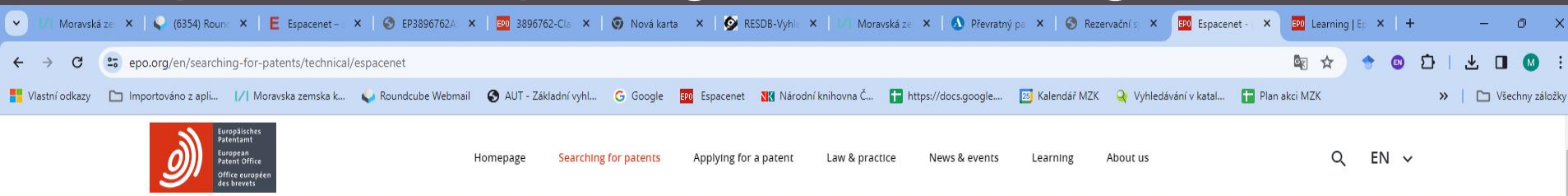

Espacenet - patent search Overview

National patent
office databases

Global Patent Index
(GPI)

Release notes

Espacenet - patent search



With its worldwide coverage and search features, Espacenet offers free access to information about inventions and technical developments from 1782 to today.

→ [National patent offices' databases](#)

→ **Open Espacenet**

→ Open classic Espacenet

Espacenet is accessible to beginners and experts and is updated daily. It contains data on more than 150 million patent documents from around the world. Supporting information can help you understand whether a patent has been granted and if it is still in force.

Espacenet

Vyhledávání



Browser tabs: Moravská zemská knihovna v B..., (6363) Roundcube Webmail :: P..., Espacenet – patent search, Moravská zemská knihovna v B...

Address bar: worldwide.espacenet.com

Navigation: Vlastní odkazy, Importováno z apli..., Moravska zemska k..., Roundcube Webmail, AUT - Základní vyhl..., Google, epo Espacenet, Národní knihovna Č..., https://docs.google..., Kalendář MZK, Vyhledávání v katal..., Plan akci MZK, Všechny záložky

Logo: **Europäisches Patentamt**
European Patent Office
Office européen des brevets

Espacenet
Patent search

Search input: (helmet* OR (head* AND protect*)) AND bicycl*

Office/Language ▾

My Espacenet Help **Classification search** Results **Advanced search** Feedback

Espacenet: free access to over 150 million patent documents



Espacenet



Vyhledávací možnosti

- Je možné zadat nanejvýš 20 výrazů.
- Lze používat operátory AND, OR a NOT.
- Náhrady znaků:
 - * neomezená délka,
 - ? 0–1 znak,
 - # 1 znak.

Náhradní znaky nelze používat na začátku slov.

Espacenet

Výsledky - nastavení



Browser tabs: Moravská zemská knihovna v B..., (6362) Roundcube Webmail v P..., Espacenet - search results, Moravská zemská knihovna v B...

Address bar: worldwide.espacenet.com/patent/search?q=%28helmet%2A%20OR%20%28head%2A%20AND%20protect%2A%29%20AND%20bicycl%2A

Navigation: Vlastní odkazy, Importováno z apli..., Moravská zemská k..., Roundcube Webmail, AUT - Základní vyhl..., Google, Espacenet, Národní knihovna Č..., https://docs.google..., Kalendář MZK, Vyhledávání v katal..., Plan akci MZK, Všechny záložky

Search bar: (helmet* OR (head* AND protect*)) AND bicycl*

Office/Language

My Espacenet Help Classification search Results Advanced search Filters Popup tips Feedback

Home > Results

121 285 results found

List view List content Sort by

Text only All Relevance

(0 patents selected) Select the first 20 results

1. Shell for a protective helmet

EP1836913A2 (A3,B1) • 2007-09-26 • FOX HEAD
Earliest priority: 2006-03-22 • Earliest publication:

Protective structures, such as helmets, and methods for manufacturing them. In other respects, one or more tunnels are formed in or integral to an outer shell for a helmet to provide ventilation, example. In other respects, an impact liner materials, such as EPS,

2. Reflecting material

US2007269669A1 (B2) • 2007-11-22 • HEADLIGHT HELMETS AB
Earliest priority: 1998-03-05 • Earliest publication: 1999-03-15

A method of manufacturing a retro-reflective shell having a curved or irregular surface for reflecting light in all directions from a laminated product, comprising a substantially flat sheet of a plastic material and a reflective layer on at least one side of said flat sheet

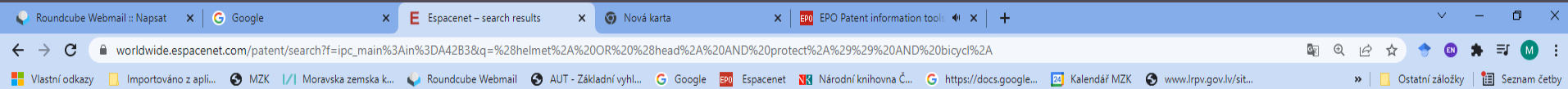

Search query: (helmet* OR (head* AND protect*)) AND bicycl*

Buttons: My Espacenet, Help, Classification search, Results, **Filters** (highlighted), Advanced search, Popup tips, Feedback

Home > Results

Query language: en / de / fr Filters: IPC main groups: **A42B3** Clear

Family

Earliest priority date

IPC main groups

IPC Class	Count
<input checked="" type="checkbox"/> A42B3	3 323
<input type="checkbox"/> A41D1	24
<input type="checkbox"/> A41D13	199
<input type="checkbox"/> A41D19	20
<input type="checkbox"/> A41D20	16
<input type="checkbox"/> A41D27	28
<input type="checkbox"/> A41D3	29

Buttons: Apply, Exclude, + query

3 323 results found

List view: Text only | List content: All | Sort by: Relevance

(0 patents selected) Select the first 20 results

1. **A Helmet**
US10791789B2 (A1) • 2020-10-06 • HEADKAYSE LTD
Earliest priority: 2015-07-07 • Earliest publication: 2017-01-12
...A **helmet** is described, more specifically a **helmet** comprising a **protective** shell (10) formed of a flexible expanded polyurethane (EPU) material which defines a cavity for receiving the wearer's **head**, the shell being foldable, the **helmet** further comprising a strap (11) arrangement for fastening the shell to the wearer's **head**.
2. **Attachment system for frontal helmet extension to a helmet**
AU2011312173A1 (B2) • 2013-05-02 • FOX HEAD INC
Earliest priority: 2010-10-05 • Earliest publication: 2012-04-12
...An attachment system for securing a frontal **helmet** extension to **protective headgear**, the attachment system including one or more magnetic elements disposed on the **helmet** and/or frontal **helmet** extension and one or more complementary elements disposed on the **helmet**... to detachably couple the frontal **helmet** extension to
3. **Reflecting material**
US2007269669A1 (B2) • 2007-11-22 • HEADLIGHT HELMETS AB
Earliest priority: 1998-03-05 • Earliest publication: 1999-03-15
A method of manufacturing a retro-reflective shell having a curved or irregular surface for reflecting light in all directions from a laminated product, comprising a substantially flat sheet of a plastic material and a reflective

Espacenet

Pokročilé vyhledávání



Roundcube Webmail :: Napsat x Google x Espacenet - search results x Nová karta x EPO Patent information tool x +

worldwide.espacenet.com/patent/search?f=ipc_main%3Ain%3DA42B3&q=%28helmet%2A%20OR%20%28head%2A%20AND%20protect%2A%29%29%20AND%20bicycl%2A

Vlastní odkazy Importováno z apli... MZK |/| Moravska zemská k... Roundcube Webmail AUT - Základní vyhl... Google EPO Espacenet Národní knihovna Č... https://docs.google... 24 Kalendář MZK www.lrpv.gov.lv/sit... Ostatní záložky Seznam četby

Espacenet Patent search Office/Language v

My Espacenet Help Classification search Results **Advanced search** Filters Popup tips Feedback

(nftxt = "helmet*" OR (ctxt = "head*" AND nftxt = "protect*")) AND ctxt = "bicycl*"

Home > Results

Query language: en / de / fr Filters: IPC main groups: A42B3 x Clear

Query language: en de fr v

AND v + Field

OR v + Field x

All text fields or names v = v -- Group

helmet* x

AND v + Field x

Title, abstract or claims v = v -- Group

head* x

All text fields or names v = v -- Group

protect* x

Title, abstract or claims v = v -- Group

bicycl* x

Search Reset

3 323 results found

List view List content Sort by

Text only v All v Relevance v

(0 patents selected) Select the first 20 results

1. A **Helmet**

US10791789B2 (A1) • 2020-10-06 • **HEADKAYSE LTD**

Earliest priority: 2015-07-07 • **Earliest publication:** 2017-01-12

...A **helmet** is described, more specifically a **helmet** comprising a **protective shell** (10) formed of a flexible expanded polyurethane (EPU) material which defines a cavity for receiving the wearer's **head**, the shell being foldable, the **helmet** further comprising a strap (11) arrangement for fastening the shell to the wearer's **head**. ...

2. **Attachment system for frontal helmet extension to a helmet**

AU2011312173A1 (B2) • 2013-05-02 • **FOX HEAD INC**

Earliest priority: 2010-10-05 • **Earliest publication:** 2012-04-12

...An attachment system for securing a frontal **helmet** extension to **protective headgear**, the attachment system including one or more magnetic elements disposed on the **helmet** and/or frontal **helmet** extension and one or more complementary elements disposed on the **helmet**... to detachably couple the frontal **helmet** extension to the **helmet** in a position where:

3. **Reflecting material**

US2007269669A1 (B2) • 2007-11-22 • **HEADLIGHT HELMETS AB**

Earliest priority: 1998-03-05 • **Earliest publication:** 1999-03-15

A method of manufacturing a retro-reflective shell having a curved or irregular surface for reflecting light in all directions from a laminated product, comprising a substantially flat sheet of a plastic material and a reflective layer on at least one side of said flat sheet plastic material. The reflective layer comprises a transparent adhesive substance and transparent

4. **Safety helmet**

US2009049586A1 • 2009-02-26 • **HEAD GERMANY GMBH**

Možnost výběru polí a kombinací operátorů

Espacenet

Pokročilé vyhledávání - výběr pole



worldwide.espacenet.com/patent/search?q=%28helmet%2A%20OR%20%28head%2A%20AND%20protect%2A%29%29%20AND%20bicycl%2A

(helmet* OR (head* AND protect*)) AND bicycl*

Office/Language

My Espacenet Help Classification search Results **Advanced search** Filters Popup tips Feedback

Home > Results

Query language: en de fr

AND + Field X

All or name =

Text fields

Names

Dates or names =

Numbers

Classifications

Other

bicycl*

122 100 results found

List view List content Sort by

Text only All Relevance

(0 patents selected) Select the first 20 results

1. Shell for a protective helmet

EP1836913A2 (A3,B1) • 2007-09-26 • FOX HEAD INC

Earliest priority: 2006-03-22 • Earliest publication: 2007-09-22

Protective structures, such as helmets, and methods for molding the same. In certain respects, one or more tunnels are formed in or integral to an outer shell for a helmet provide ventilation, example. In other respects, an impact liner materials, such as EP

2. Reflecting material

US2007269669A1 (B2) • 2007-11-22 • HEADLIGHT HELMETS AB

Earliest priority: 1998-03-05 • Earliest publication: 1999-03-15

A method of manufacturing a retro-reflective shell having a curved or irregular surface reflecting light in all directions from a laminated product, comprising a substantially flat sheet of a plastic material and a reflective layer on at least one side of said flat sheet

3. SAFETY HELMET

WO2022266709A1 • 2022-12-29 • HEADLOK PTY LTD

Earliest priority: 2021-06-22 • Earliest publication: 2022-12-29

The invention relates to a safety helmet which includes a wearable helmet body for protecting a wearer's head and an adjustable strap for securing the helmet body to the

Text fields

Title

Abstract

Description

Claims

Title or abstract

Title, abstract or claims

All text fields

Search Reset

Espacenet

Nastavení seznamu výsledků



Roundcube Webmail: Napsat x Google x Espacenet - search results x Nová karta x +

worldwide.espacenet.com/patent/search?f=ipc_main%3Ain%3DA42B3&q=%28nftxt%20%3D%20%22helmet%2A%20OR%20%28cxt%20%3D%20%22head%2A%20AND%20nftxt%20%3D%20%22protect%2A%29%29%20AND%20cxt%20%3D%20%22bic...
Vlastní odkazy Importováno z apli... MZK I/I Moravská zemská k... Roundcube Webmail AUT - Základní vyhl... Google EPO Espacenet NK Národní knihovna Č... https://docs.google... 24 Kalendář MZK www.lrpv.gov.lv/sit... » Ostatní záložky Seznam čety

Espacenet Patent search (nftxt = "helmet*" OR (cxt = "head*" AND nftxt = "protect*")) AND cxt = "bicycl*" Office/Language

My Espacenet Help Classification search Results Advanced search Filters Popup tips Feedback

Home > Results
Query language: en / de / fr Filters: IPC main groups: Clear

Query language: en de fr

AND + Field

OR + Field X

All text fields or names =

helmet*

AND + Field X

Title, abstract or claims =

head*

All text fields or names =

protect*

Title, abstract or claims =

bicycl*

830 results found

View	List content	Sort by
Text only	All	Relevance
Text and thumbnails	0 results	
Compact list	ELMET WITH INTERNAL VENTILATION SYSTEM	
Drawings only	D • BELL SPORTS INC [US]	

- ...A bicycle helmet for protecting the head of a wearer includes an outer shell and an energy dissipating inner layer... for supporting the helmet upon the head of the wearer. The internal ventilation system provides a gap between the head of the wearer and the inner surface. The gap allows ventilating air to flow over a substantial extent of the wearer's head and
2. Head protector used for bicycle
CN108236158A • 2018-07-03 • TIANJIN FENGKAI TECH CO LTD
Earliest priority: 2016-12-26 • Earliest publication: 2018-07-03
...The invention discloses a head protector used for a bicycle. The head protector used for a bicycle comprises a helmet body, wherein a solar panel is arranged at the top end of the outside of the helmet body, air outlets... is prevented from disturbance, and thus improving the riding safety and meeting the requirement of riders of the modern society on helmets
3. Bicycle intelligence head protective equipment that adaptation head form changes
CN207870376U • 2018-09-18 • CHENGDU YIZHONGLI NETWORK TECH CO LTD
Earliest priority: 2018-01-03 • Earliest publication: 2018-09-18
...The utility model discloses a bicycle intelligence head protective equipment that adaptation head form changes, including helmet shell body, helmet... for below 13 of helmet shell body surface area, surface cover at helmet shell body has outer protecting film, be... worn, avoids the helmet and head form improper and lead to the not hard up phenomenon
4. Head type self-adaptive bicycle helmet
CN213695885U • 2021-07-16 • NANJING CHUOING ELECTRONIC TECH CO LTD

Možnost nastavení:

- způsob zobrazení výsledků,
- zobrazení všech nebo vybraných výsledků,
- pořadí výsledků.

Tisk či download vybraných výsledků.

Espacenet

Stahování či tisk výsledků



Browser tabs: (5605) Roundcube Webmail, Google, Espacenet - search results, Nová karta, Moravská zemská knihovna v Brně

Address bar: worldwide.espacenet.com/patent/search?f=ipc_main%3Ain%3DA42B3&q=%28nftxt%20%3D%20%22helmet%2A%20OR%20%28cxt%20%3D%20%22head%2A%20AND%20nftxt%20%3D%20%22protect%2A%29%29%20AND%20cxt%20%3D%20%22bic...

Search bar: (nftxt = "helmet*" OR (cxt = "head*" AND nftxt = "protect*")) AND cxt = "bicycl*" [Search]

Office/Language [v]

My Espacenet Help Classification search Results [Advanced search] [Filters] [Popup tips] Feedback

Home > Results

Query language: en / de / fr Filters: IPC main groups: A42B3 [x] Clear

830 results found

List view: Text only | List content: All | Sort by: Relevance

(2 patents selected) Select the first 20 results

1. **PROTECTIVE BICYCLE HELMET WITH INTERNAL VENTILATION SYSTEM**
WO2013152322A1 • 2013-10-10 • BELL SPORTS INC [US]
Earliest priority: 2012-04-06 • Earliest publication: 2013-10-10
...A bicycle helmet for protecting the head of a wearer includes an outer shell and an energy dissipating inner layer... for supporting the helmet on the head of a wearer. The internal ventilation system provides a gap between the head of the wearer and the inner surface. The gap allows ventilating a portion of the extent of the wearer's head and within the helmet. ...

2. **Head protector used for bicycle**
CN108236158A • 2018-07-03 • TIANJIN FENGKAI TECH CO LTD
Earliest priority: 2016-12-26 • Earliest publication: 2018-07-03
...The invention discloses a head protector used for a bicycle. The head protector used for a bicycle comprises a helmet body, wherein a solar panel is arranged at the top end of the outside of the helmet body, air outlets... is prevented from disturbance, and thus improving the riding safety and meeting the requirement of riders of the modern society on helmets of the bicycle. ...

3. **Bicycle intelligence head protective equipment that adaptation head form changes**
CN207870376U • 2018-09-18 • CHENGDU YIZHONGLI NETWORK TECH CO LTD
Earliest priority: 2018-01-03 • Earliest publication: 2018-09-18
...The utility model discloses a bicycle intelligence head protective equipment that adaptation head form changes, including helmet shell body, helmet... for below 13 of helmet shell body surface area, surface cover at helmet shell body has outer protecting film, be... worn, avoids the helmet and head form improper and lead to the not hard up phenomenon of the helmet to ...

4. **Head type self-adaptive bicycle helmet**
CN213695885U • 2021-07-16 • NAN JING CHUQING ELECTRONIC TECH CO LTD

Menu

- Download
- List (xlsx)
- List (csv)
- Front pages (pdf)
- Print
- Add selection to My patents
- Share this query

Espacenet

Ukládání výsledků do osobní schránky

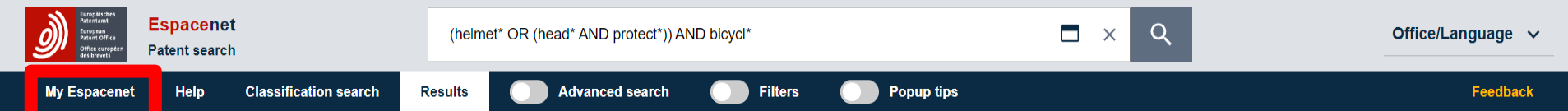
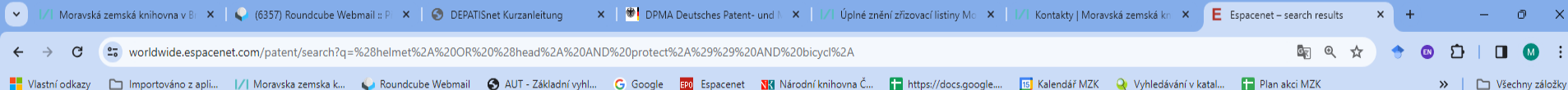

Home > Results

121 235 results found

List view: Text only | List content: All | Sort by: Relevance

(3 patents selected) Select the first 20 results

1. Shell for a protective helmet

EP1836913A2 (A3,B1) • 2007-09-26 • FOX HEAD INC

Earliest priority: 2006-03-22 • Earliest publication: 2007-09-22

Protective structures, such as helmets, and methods for molding the same. In certain respects, one or more tunnels are formed in or integral to an outer shell for a helmet to provide ventilation, example. In other respects, an impact liner materials, such as EPS, may be directly in-molded to shells suitable for use in motorcycle helmets and other helmets ...

2. Reflecting material

US2007269669A1 (B2) • 2007-11-22 • HEADLIGHT HELMETS AB

Earliest priority: 1998-03-05 • Earliest publication: 1999-03-15

A method of manufacturing a retro-reflective shell having a curved or irregular surface for reflecting light in all directions from a laminated product, comprising a substantially flat sheet of a plastic material and a reflective layer on at least one side of said flat sheet plastic material. The reflective layer comprises a transparent adhesive substance and transparent glass or plastic pearls with a diameter between 0.01 and 0.05 mm. The substance

3. SAFETY HELMET

WO2022266709A1 • 2022-12-29 • HEADLOK PTY LTD

Earliest priority: 2021-06-22 • Earliest publication: 2022-12-29

The invention relates to a safety helmet which includes a wearable helmet body for protecting a wearer's head and an adjustable strap for securing the helmet body to the wearer's head. The helmet further includes a locking arrangement integrated with the helmet body and a locking member comprising

Menu

- Download
- Print
- Add selection to My patents**
- Share this query



Hledání podle Cooperative Patent Classification (CPC)

Classification search

helmet* Search Index | A | B | C | D | E | F | G | H | Y |

Classification symbol Title and description

★★★★★	<input checked="" type="checkbox"/> A42B 3/00	Helmets; Helmet covers (for other protective head coverings) (hoods for welders A61F 9/06); defence protection helmets F41H 1/04)
★★★★★	<input type="checkbox"/> G02B 27/00	Optical systems or apparatus not provided for by any of the groups G02B 1/00 - G02B 26/00 , G02B 30/00
★★★★★	<input type="checkbox"/> A41D 13/00	Professional, industrial or sporting protective garments, e.g. surgeons' gowns or garments protecting against blows or punches (helmets A42B 3/00 ; clothing affording protection against chemical agents or for use at high altitudes A62B 17/00 ; life-saving garments for use at sea, diving suits B63C ; bulletproof or armoured clothing F41H ; clothing affording protection against radiation G21F 3/02)
★★★★★	<input type="checkbox"/> A62B 18/00	Breathing masks or helmets, e.g. affording protection against chemical agents or for use at high altitudes (for incorporating a pump or compressor for reducing the inhalation effort) (A62B 17/00 takes precedence; anaesthetic masks A61M 16/06)
★★★★★	<input type="checkbox"/> G08B 21/00	Alarms responsive to a single specified undesired or abnormal operating condition and not elsewhere provided for
★★★★★	<input type="checkbox"/> H04R 1/00	Details of transducers , (loudspeakers or microphones)
★★★★★	<input type="checkbox"/> F41H 1/00	Personal protection gear (shields for personal use F41H 5/08 ; (footwear for use in minefields A43B 3/0026); for protection against chemical warfare A62B)
★★★★★	<input type="checkbox"/> A42C 2/00	Manufacturing helmets by processes not otherwise provided for
★★★★★	<input type="checkbox"/> A62B 7/00	Respiratory apparatus (for medical purposes A61M 16/00)

Selected classifications

A42B3/00/low X

Clear

Find patents

3 možnosti práce s třídíkem:

- hledání podle slov,
- hledání určité notace / určitého symbolu,
- postupné rozklikávání notace od obecného ke specifickému.

Espacenet

Stažení záznamů ve formátu xlsx



Espacenet_search_result_-_front_page_selection_202110041557 - Excel

No	Title	Inventors	Applicants	Publication number	Earliest priority	IPC	CPC	Publication date	Earliest publication	Family number
1	BICYCLE HELMET WITH VENTILATION PLATE	GOSSEEN NICHOLAS REID [US] KRYNOCK MIKE [US] OKAMURA ALAN [US]	SPECIALIZED BICYCLE COMPONENTS INC [US]	US2019183203A1	2017-12-15	A42B3/12 A42B3/28	A42B3/12 A42B3/28		2019-06-19	064654646
2	Protective bicycle helmet with internal ventilation system	PIETRZAK CHRIS T	BELL SPORTS INC BELL SPORTS INC [US]	AU2013243315A1 AU2013243315B2	2012-04-06	A42B3/00 A42B3/06 A42B3/28	A42B3/00 A42B3/06 A42B3/28		2013-10-10	049291129
3	MACHINE-VENDIBLE FOLDABLE BICYCLE HELMET METHODS AND SYSTEMS	SHIFFER ISIS [US]	SHIFFER ISIS [US] MEMBRAIN SAFETY SOLUTIONS LLC [US]	US10959480B2 US2019142100A1	2016-09-13	G09F21/02 G09F23/00 A42B3/06 A42B3/32 A42B3/12	A42B3/06 G09F23/00 A42B3/06 A42B3/32 A42B3/12		2018-03-20	061607131
4	Bicycle helmet	BULLOCK CHRISTOPHER [US] PIETRZAK CHRIS [US]	SPECIALIZED BICYCLE COMPONENTS [US]	US2006248630A1 US7376980B2	2005-04-20	A42B7/00	A42B3/066 (EP) A42B3/08 (EP) A42B3/147 (EP) A42B3/28 (EP)	2006-11-09 2008-05-27	2006-10-25	036590231
5	Wireless-sensor-based intelligent electric bicycle helmet management system	SHAO YUNLIAN	UNIV HUAIYIN NORMAL	CN110179195A	2019-05-30	A42B3/04	A42B3/0406 (CN) A42B3/0433 (CN) A42B3/0466 (CN)	2019-08-30	2019-08-30	067718657
6	Bicycle helmet	SPERBER GERHARD [DE]	ELASTO FORM [DE]	US5687426A	1993-02-25	A42B3/00 A42B3/04 A42B3/06 A42B3/12 A42B3/28 A42C2/00	A42B3/061 (EP) A42B3/066 (EP) A42B3/12 (EP) A42B3/281 (EP) A42C2/00 (EP)	1997-11-18	1997-11-18	027544664
7	Bicycle helmet	EGGER F ROBERT [US]	SPECIALIZED BICYCLE COMPONENTS [US]	US6105176A	1993-09-17	A42B3/00 A42B3/00 A42B3/06	A42B3/066 (EP) A42B3/125 (EP) A42B3/28 (EP)	2000-08-22	1995-09-19	022410504

Espacenet

Statistické analýzy patentů pomocí filtrů



worldwide.espacenet.com/patent/search?q=cpc%20%3D%20"A42B3%2F00%2Flow"%20AND%20ctxt%20%3D%20"bicycle%2A"&queryLang=en%3Ade%3Afr



Espacenet
Patent search

cpc = "A42B3/00/low" AND ctxt = "bicycle**"

Office/Language

My Espacenet

Help

Classification search

Results

Advanced search

Filters

Popup tips

Feedback

Home > Results

Family Publication

Download

Filters

Countries (publication)

Languages (publication)

Publication date (publication)

Family

Earliest priority date

IPC main groups

IPC subgroups

Countries (publication)	Number of documents
US	327
3 CN	111
4 WO	99
5 KR	86
6 EP	80
7 DE	48
8 CA	31
9 GB	25
10 JP	25
11 AU	24
12 ES	8
13 FR	8
14 TW	7
15 SE	6
16 IT	4
17 MX	2
18 RU	2
19 BE	1
20 CH	1
21 NL	1
22 PL	1
23 SG	1
24 SI	1
25	
26	
27	
28	
29	
30	
31	
32	
33	
34	
35	
36	
37	
38	
39	
40	

Espacenet

Statistické analýzy patentů pomocí filtrů – grafy

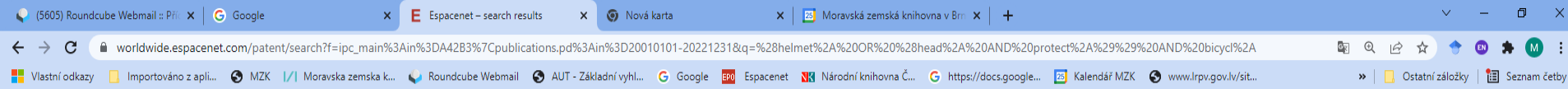

Espacenet
Patent search

(helmet* OR (head* AND protect*)) AND bicycl*

Office/Language

My Espacenet

Help

Classification search

Results

Advanced search

Filters

Popup tips

Feedback

Home > Results

Query language: en / de / fr Filters: IPC main groups: A42B3 Publication date (publication): 2001-01-01 — 2022-12-31

Family Publication

Countries (publication)

Languages (publication)

Publication date (publication)

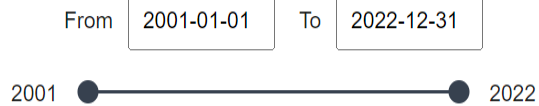

2 893 results

List view

Text only

(0 patents)

1. A Hel...

US1079178...

Earliest prio...

...A helmet is c...

) formed of a f...

for receiving th...

2. Attach...

AU2011312...

Earliest prio...

...An attachment system for securing a frontal helmet extension to protective headgear, the attachment system including one or more magnetic elements disposed

2 893 results found for: (helmet* OR (head* AND protect*)) AND bicycl*

Query language: en / de / fr Filters: IPC main groups: A42B3 Publication date (publication): 2001-01-01 — 2022-12-31 Clear

Countries (publication)	Languages (publication)	Publication date (publication)	Earliest priority date
US	en	From 2001-01-01 To 2022-12-31	From 1989-01-01 To 2021-12-31
CN	zh		
WO	ko		
KR	ja		
EP	de		
JP	fr		
CA	es		
	it		

Line graph showing publication trends from 2001 to 2022. The y-axis ranges from 150 to 600. The x-axis shows years from 2001 to 2022. The graph shows a steady increase in publications over time, reaching approximately 600 by 2022.

Line graph showing earliest priority date trends from 1989 to 2021. The y-axis ranges from 80 to 320. The x-axis shows years from 1989 to 2021. The graph shows a steady increase in earliest priority dates over time, reaching approximately 320 by 2021.

Espacenet

Záznam patentového dokumentu

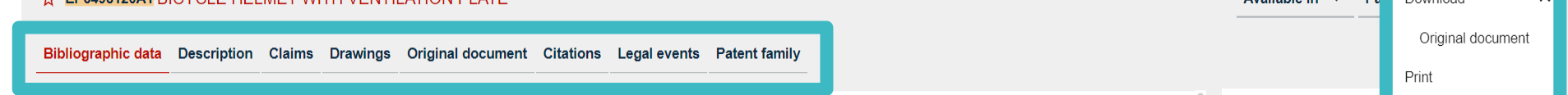
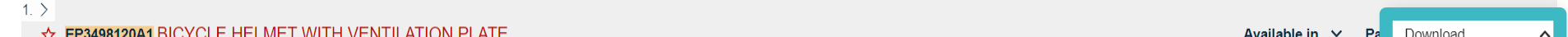
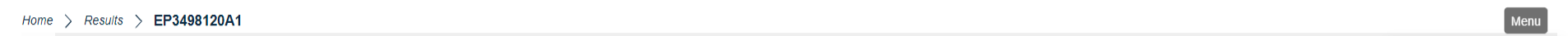
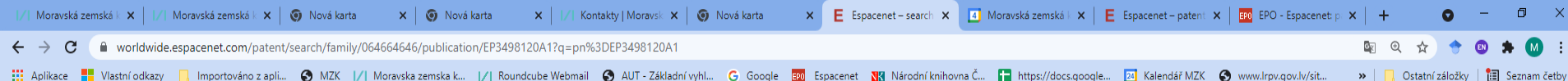

Register [Global Dossier](#)

Applicants SPECIALIZED BICYCLE COMPONENTS INC [US] +

Inventors GOSSEEN NICHOLAS REID [US]; KRYNOCK MICHAEL JOSEPH [US]; OKAMURA ALAN [US] +

Classifications

IPC A42B3/06; A42B3/28;

CPC A42B3/0493 (US); A42B3/06 (US); A42B3/066 (EP,US); A42B3/28 (EP,CN,US); A42B3/283 (CN,US);

Priorities US201762599565P-2017-12-15

Application EP18211541A-2018-12-11

Publication EP3498120A1-2019-06-19

Published as CN109998215A; EP3498120A1; US2019183203A1

Available in [Download](#)

- Original document
- Print
- Share this patent

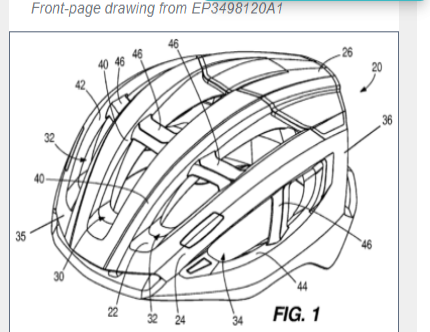

Espacenet Automatický překladač

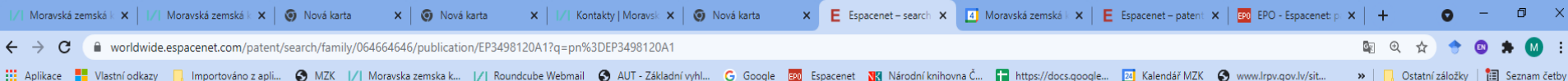

Home > Results > EP3498120A1

1. >

☆ EP3498120A1 BICYCLE HELMET WITH VENTILATION PLATE

Bibliographic data Description Claims Drawings Original document Citations Legal events Patent family

Register ↗ Global Dossier ↗

Data originating from sources other than the EPO may not be accurate, complete, or up to date.

CROSS-REFERENCE TO RELATED APPLICATIONS

[0001] This application claims priority to U.S. Provisional Application No. 62/599,565, filed December 15, 2017 .

BACKGROUND

[0002] The present invention relates generally to the field of bicycle helmets and specifically to bicycle helmets designed for improved ventilation.

[0003] Bicycle helmets are designed to protect a user's head in the event of an accident. Bicycle helmets typically include a thick liner of expanded polystyrene (EPS) covered with a thin shell of a hard plastic material, such as lexan, polycarbonate, or acrylonitrile butadiene styrene (ABS).

[0004] In order to increase a user's comfort when riding a bicycle, bicycle helmets may be designed to be lightweight and/or to have ventilation so that the user's head is cooled while riding. For example, ventilation may include inlet ventilation ports on the front of the bicycle helmet and outlet ventilation ports on the rear of the bicycle helmet, thereby facilitating the flow of air through the bicycle helmet. As bicycle helmet design has evolved, ventilation ports have generally become larger and more numerous in order to increase the amount of air flowing through the helmet.

[0005] As the size of ventilation ports have increased, reinforcing struts have been added to enhance the strength of the bicycle helmet. These struts can extend laterally across the ventilation ports in order to provide strength to the underlying liner. Struts can be made of a variety of materials, such as plastic mesh or plastic strip, and the struts are often covered with a layer of EPS.

BRIEF DESCRIPTION OF THE DRAWINGS

[0006]

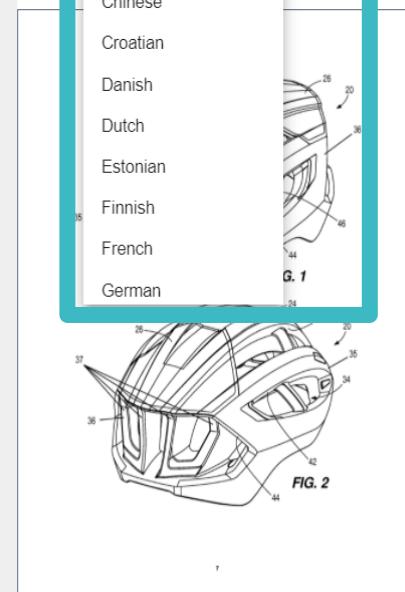
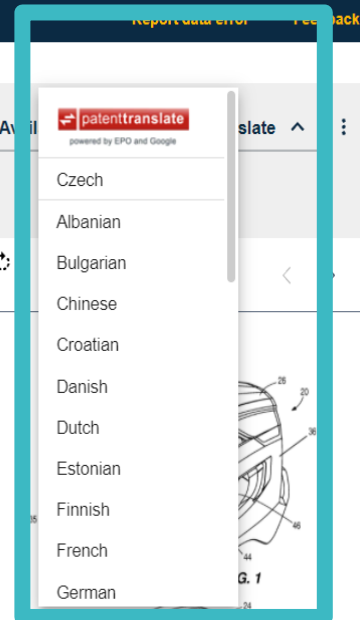

Espacenet – My Espacenet



Vybrané patentové dokumenty, historie dotazů, natavení osobních preferencí.

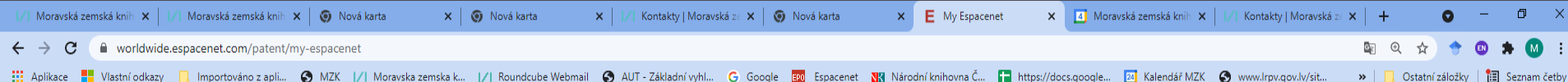

Espacenet Patent search Office/Language

My Espacenet Help Classification search Results Popup tips Feedback

My patents **My queries** My settings

Query	Filters	Languages	Date	Results found	Actions
in all "Vi#tor Kaplan" AND (num any "CS" OR any "AT")		en:de:fr	2021-10-04 13:57:34	45	▶ 🗑️
ia all "Vi#tor Kaplan" AND D cbxt all "turbine"		en:de:fr	2021-10-04 13:53:08	43	▶ 🗑️
(helmet* OR (head* AND protect*)) AND bicycle*		en:de:fr	2021-10-04 12:33:04	94 362	▶ 🗑️
helmet* AND bicycle*		en:de:fr	2021-10-04 11:14:25	12 203	▶ 🗑️
helmet* AND bicycle*		en:de:fr	2021-10-04 11:12:01	10 856	▶ 🗑️
seat* AND (portable OR movable)		en:de:fr	2021-10-04 11:08:27	1 941 895	▶ 🗑️
(pet* OR dog*) AND umbrella*		en:de:fr	2021-10-04 11:05:02	34 062	▶ 🗑️
(pet* OR animal* OR dog* OR cat*) AND umbrella*			2021-10-04 11:04:28	0	▶ 🗑️
(pet* OR animal* OR dog* OR cat*) AND umbrella* AND A01K13*			2021-10-04 11:03:39	0	▶ 🗑️
(pet* OR animal* OR dog			2021-10-04 11:03:24	0	▶ 🗑️

PhDr. Martina Machátová

Moravská zemská knihovna v Brně

Tel.: 541 646 170

E-mail: Martina.Machatova@mzk.cz